

16" Hygienic BoxDrain400 Channels

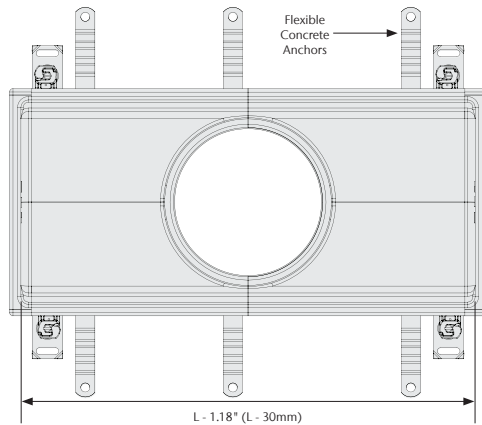
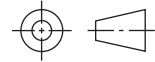

Specification Clause

ACO Hygienic BoxDrain. Overall length and height varies, see tables. Made from 16ga (1.5 mm) AISI 304 or AISI 316L, pickle passivated finish. Used with 12" Floor Drains. Number of concrete anchors and adjustable leveling feet varies by channel length. Multiple grate options available. Certified to NSF/ANSI/3-A Standard 14159-1.

ACO recommends checking local plumbing codes prior to installation.

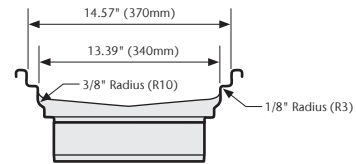
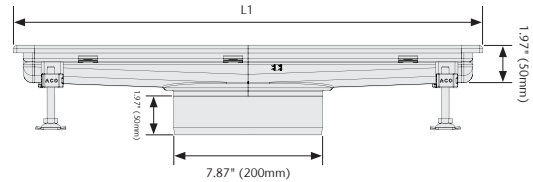
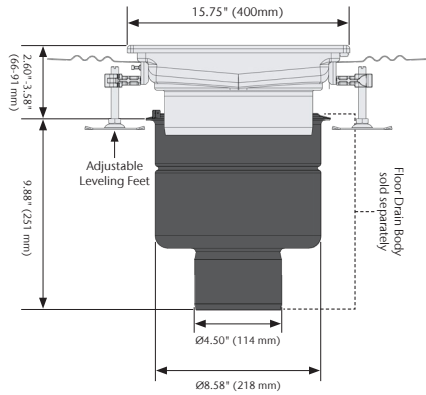

Part No.	Length (L1) in (mm)	Material	Weight lbs
416645	17 (430)	AISI 304	8.6
416651	17 (430)	AISI 316L	8.6
416646	25 (630)	AISI 304	11.1
416652	25 (630)	AISI 316L	11.1
416647	33 (830)	AISI 304	13.8
416653	33 (830)	AISI 316L	13.8

ACO, Inc.

West Sales Office
825 W. Beechcraft Street
Casa Grande, AZ 85122
Tel: (520) 421-9988
Toll-Free: (888) 490-9552
Fax: (520) 421-9899

Northeast Sales Office
9470 Pinecone Drive
Mentor, OH 44060
Tel: (440) 639-7230
Toll-Free: (800) 543-4764
Fax: (440) 639-7235

Southeast Sales Office
481 Munn Road
Suite 225
Fort Mill, SC 29715
Toll-Free: (800) 543-4764
Fax: (803) 802-1063

info@acousa.com
www.acousa.com

© March 2023 ACO, Inc.

All reasonable care has been taken in compiling the information in this document. All recommendations and suggestions on the use of ACO products are made without guarantee since the conditions of use are beyond the control of the company. It is the customer's responsibility to ensure that each product is fit for its intended purpose and that the actual conditions of use are suitable. ACO, Inc. reserves the right to change products and specifications without notice.

ACO. we care for water



ACO Specification Information